



LETTRE URGENTE DE LA FIE

Urgent Letter 3-10
8 February 2010

Urgent decisions

a) Transparent masks

Dear President,

The FIE Executive Committee took the following urgent decisions at its meeting of February 6, 2010 in Lausanne:

Further to the urgent letter 15-09, the FIE has received the conclusions (attached) of the *Sabic Innovative Plastic lab (NED)*, relative to the mask damaged in Odense. This lab points out two major facts:

- the analysed visor presents stresses linked to its making (injection moulding, instead of hot bend and cold setting recommended by the FIE); stress marks clearly appear at the plastic injection juncture points;
- due to the lack of protection coating against deterioration and scratches, the visor presented several significant scratches.

And moreover, some manufacturing standards imposed by the FIE Equipment Rules have not been completely adhered to.

Therefore, the Executive Committee has decided to suspend and forbid, until further notice, the use of the transparent visor mask both in foil and epee, at all FIE official competitions.

The FIE will set up a working group (SEMI Commission, manufacturers, specialised institute) whose objectives will be the following:

- reinforce the standards imposed by the FIE Rules (i.e. make mandatory what was recommended or optional);
- establish systematic verification processes during the equipment control;
- enlarge the security standards.

Page 2/2

b) Kuwait Fencing Federation

As was announced in the urgent letter 1-10, the FIE Executive Committee took a decision regarding the situation of the Kuwait Fencing Federation, following the suspension of the Kuwait National Olympic Committee by the IOC.

In accordance with articles 1.1, 1.2.8 et 2.1.1 a) and b) of the FIE Statutes, the Executive Committee has decided to suspend Kuwait Fencing Federation, pending a further decision by the IOC.

This decision also applies to the athletes, referees and elected members of the Federation

c) 2009-2010 calendar

The Egyptian Fencing Federation has confirmed that it will organise its Senior Women's Foil and Men's Foil competitions in Cairo.

The Senior Men's Foil competition will take place on March 20 and 21, 2010.

The Senior Women's Foil competition will take place on March **19 and 20, 2010**, i.e. one day later than initially planned.

The FIE Executive Committee accepted this change at the request of the Egyptian Fencing Federation. In addition, no entries had been registered when the request was made.

Alisher Usmanov
President

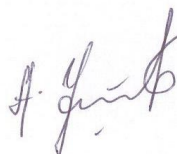

LIMS Requestnr. :	LIMS CTS-10-00013	Type of report :	Technical
Author(s) :	Fred Bartelen	Number of pages :	13
Department :	SF&S Technology	Date :	19-01-2010

Title : Investigation of the fracture of a lexan fencing mask visor upon impact during the Junior World Championship in November 2009 in Odensee.

Visor is manufactured by Uhlmann-fechtsport Germany

Objective : Find a cause for this breakage issue .

Results/Summary: Breakage of this visor during impact is believed to related to several issues found:

- Notch initiation triggered from the injection-moulding gate.
- Severly damaged/scratched visor surface.
- Cutting action of metal cover frame.
- Assembly stress introduced during mounting of the metal cover frame
- Use of chemicals. Including but not limited to the presence of PVC plasticisers in the mask itself and carrying/storage materials.
- Differences in visor radius versus mask and top metal frame
Will cause a high local stress.

Conclusion : A remarkable outcome of this evaluation was that material used is not Sabic Innovative Plastic polycarbonate with brandname LEXAN. The visor was manufactured by means of an injection moulding process stead drapeforming. Material used was an uncoated polycarbonate.

In view of the fracture location it is very likely that the fracture of the visor was triggered by notch initiation of the microcrazed gate area. Presence of severe surface damages and very sharp edges of the metal cover frame were also found. These also can have a very negative effect on the impact performance of such a visor.

Several improvements eg. Advises can be found below.

Keywords : Lexan CTG/AF . Uhlmann-fechtsport. fencing mask window.
impact, fracture mechanics

Introduction:

For better understanding of the encountered issue (breakage of lexan) an abstract is given below on the effect of notches on polycarbonate.

1. Effect of notches on Polycarbonate

The strength of materials is often lower than can be expected from theoretical predictions because the applied stress is amplified by minute internal defects, also known as Griffith cracks. These cracks or notches act as stress concentrators. Fracture mechanics originates from this concept. It aims for a quantitative characterization of the conditions under which a load-bearing solid containing a sharp crack/notch will fail.

1.1. Fracture mechanics

Many failure phenomena in materials can be described with Linear Elastic Fracture Mechanics (LEFM) using K_I (stress intensity factor) and G_c (energy release rate). These parameters are widely used for characterization of the fracture behaviour of polymers, particularly for fracture in plane strain.

1.1.1. Stress intensity factor

The stress field around a crack tip in a loaded plate containing a small sharp crack is considered, when a remote stress, σ , is applied. Three modes of crack opening are distinguished, of which mode I is the most important: crack opening perpendicular to the crack plane.

The stress distribution around the crack tip can be described by equation 1:

$$\sigma_{ij} = \frac{K_I}{\sqrt{2\pi r}} f_{ij}(\theta)$$

Where f_{ij} is a function of the angle θ from the crack plane.

The stress distribution is fully characterized by the stress intensity factor K_I

$$K_I = Y \sigma_{\infty} \sqrt{a}$$

where σ_{∞} is the remote applied stress and a is the crack length. Y is a geometric factor. When the stress intensity factor K_I exceeds a certain critical value K_{Ic} , the crack will grow and lead to failure. The stress intensity criterion is only valid for linear elastic materials, so this criterion can be used to describe brittle fracture. It appeared that K_{Ic} depends on test rate and temperature.

1.1.2. Energy release rate

Another parameter from Linear Elastic Fracture Mechanics is G (energy release rate). This approach states that crack growth can only occur if the release of elastic energy, G , is higher than the energy necessary for formation of the crack surface, G_c . This gives a measure for the energy necessary for crack growth per unit area, the critical release agent G_c .

For linear elastic materials the energy necessary for crack growth consists only of the surface energy involved in the creation of crack surface. Considering polymers however, plastic deformation takes place next to the fracture plane. When the size of this plastic zone is very small compared to the specimen dimensions, the G -criterion is still valid. When the plastic zone becomes too large, other methods have to be used that take into account the energy dissipated by the plastic deformation during fracture.

When the materials behave in a linear elastic manner the two criteria K_{Ic} and G_{Ic} are related. It can be shown that:

$$G_{Ic} = \frac{K_{Ic}^2}{E^*}$$

Where $E^* = E$ (Young's modulus) for plane stress and $E^* = E/(1-\nu^2)$ for plane strain. Furthermore it can be shown that

$$G_{Ic} = \frac{U}{BW\phi}$$

where U is fracture energy, B is the specimen thickness, W is the width and ϕ is a correction factor that depends on the specimen compliance C and a/W ratio. This allows for the determination of G_{Ic} directly from the slope of the relationship between fracture energies, U , and $BW\phi$ obtained from experiments on specimens with different initial crack lengths.

The LEFM approach can be used when the size of the plastically deformed zone at the crack tip is small, i.e. less than 2% of the specimen dimensions and when the deformation at the crack tip occurs under plane strain conditions. The shape and size of the plastic zone can be described by:

$$r_p = \frac{1}{2\pi} \left(\frac{K_I}{\sigma_y} \right)^2 \cos^2 \frac{\theta}{2} \left[4(1-\nu + \nu^2) - 3 \cos^2 \frac{\theta}{2} \right]$$

The plastic zone is much larger for the plane stress case than for the plane strain case, because of the higher constraint of plane strain, since lateral strain is obstructed in the plane strain situation. In the plane stress case a larger portion of the material can participate in energy

absorption. Fracture toughness is closely related to the plastic zone size and will be minimal when the zone is at its smallest. This will be the case under full plane strain conditions. For a notched specimen or sheet, plane strain condition will exist in the center region. The surfaces are in plane stress and the center region can be in plane strain. So a complete plane strain situation is in principle never achieved. This results in a dog-bone shaped plastic zone. See figure 5.

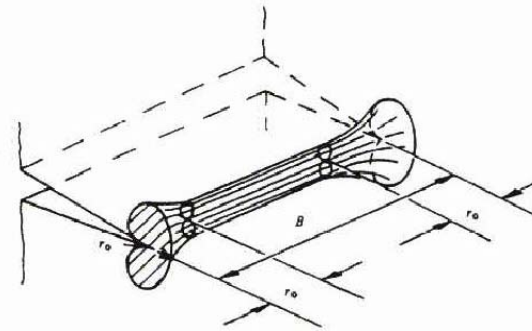

It was found empirically that LEFM can be used when three specimens geometry conditions are met:

$$B, (W-a) \text{ and } a > 2.5 (K_{Ic}/\phi_y)^2$$

For a polycarbonate specimen with a sharp notch, K_{Ic} is typically 2.24 and $\phi_y = 64$ Mpa. The calculation for the necessary specimen dimensions indicates that a PC specimen with thickness > 3 mm would fracture under plane strain conditions. However, for PC-specimens that meet this condition, extensive plastic deformation is still visible.

As mentioned before the LEFM approach cannot be used to describe the fracture behaviour of ductile-fracturing materials, because of the large size of the plastic zone near the crack tip.

For materials that show extensive plastic deformation, other methods are available, such as the J-integral or the essential work-of-fracture method. When large plastic deformations occur in a material, at high test speeds the deformation is expected to lead to local warm-up of the material. The resulting increase in local material temperature is a function of test rate and the amount of deformation in the material.

1.1.3. J-integral

The parameter J may be considered as the rate of change of potential energy with extension of the crack. For linear elastic materials, J equals G. Crack growth will occur when J exceeds a critical value J_{Ic} . It can be shown that:

$$J = 2U/Bl$$

Where u is the total energy under the load-deflection curve, and l is (W-a).

This equation simplifies the analysis needed to determine the critical J value of the onset of crack growth. Several ASTM E813 standard method for J-integral measurements exist.

View of failed fencing mask – FIE 1600 N – code GCN 09011017 M 2005

Brand : Uhlmann – Fechtsport Germany



Mask code : **GCN 09011017 M 2005**

2. Visual assessment :

The visor was inspected by means of polarized light and it was found then that visor was not manufactured from a sheeted product. This visor was injection moulded. Three gates were found in the bottom edge of the visor and also the polarized stress pictures clearly shows the infill pattern of the material in the mould (see pictures below).

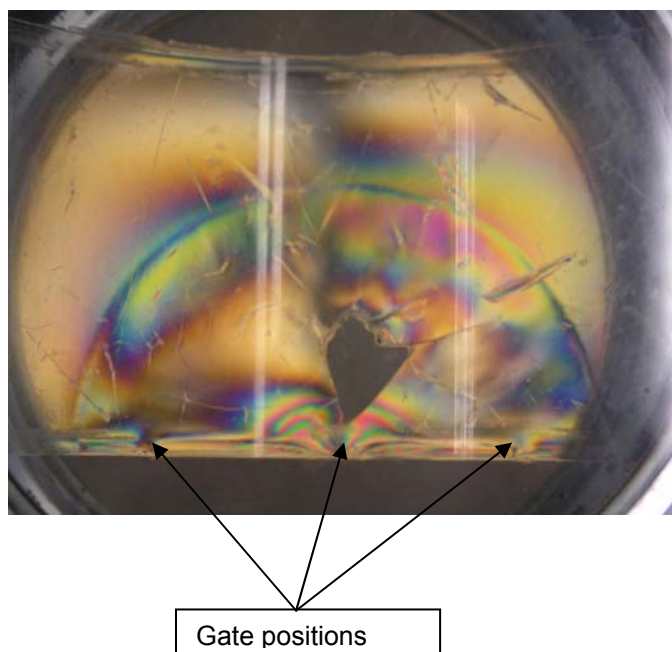

It was then checked if a coating was present on both outside and inside surfaces by means of an ATR/FTIR evaluation. By means of this technique it could be concluded that no coating was present and material of the visor is polycarbonate.

Sample was then tested by using thermal desorption gas chromatography-electron ionization mass spectrometry (TDS-GC-MS-EI) to check the presence of released volatiles. Thermal desorption of the material and on-line GC-MS analysis gives a very detailed picture of the compounds present in the sample.

MS detection clearly demonstrates not the common used additives from our material (Sabic). Obtained chromatogram shows the presence of several typical products, which are an indication that the material was made of a competitive PC (like DOW, Enichem or Teijin).

Main conclusion from these studies is that visor is made from an unknown PC product. The brand coding (Lexan) on this visor is therefore seriously questioned. It needs to be mentioned further that resin type of the polycarbonate is very relevant. For the manufacturing of lexan sheeted products high viscous polycarbonate resin is used. Such products will have an improved impact performance and modestly better chemical performance.

2.1. Visual assessment of failure area

The failure typically started at the bottom edge of the visor. A piece of the material was blown out the surface upon impact. Upon observing the visor in a light beam stress crazes were seen in the middle bottom side of the visor (crack initiation point) over a distance of plus minus 10 mm. Same craze phenomena were also observed in the top side middle section. Here also a small crazes was seen in the surface. This craze seems to have started on the rebate edge of the metal cover frame.

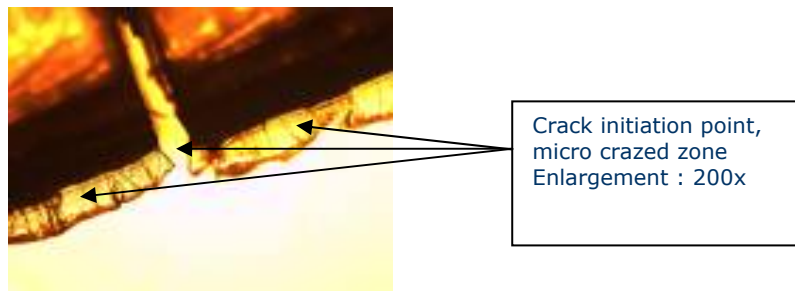
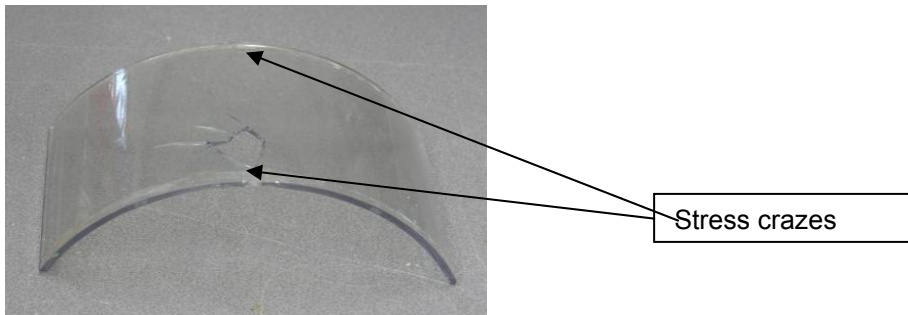

Crack edges are typically showing a brittle fracture at the starting point and then changing to a more ductile failure like tearing. This is indicative that initial failure was triggered by a notch alike origin. There were several factors, which can have triggered this. First the presence of the small micro crazes in the bottom edge of the visor. These crazes were found to coincide with the cut off gate of the used runner system used for injection moulding of this visor. It's known that such areas can have a considerable higher stress level. Two other factors for notch initiation are the presence of scratch marks on the visor surface and the relative sharp edges of the metal cover plate.

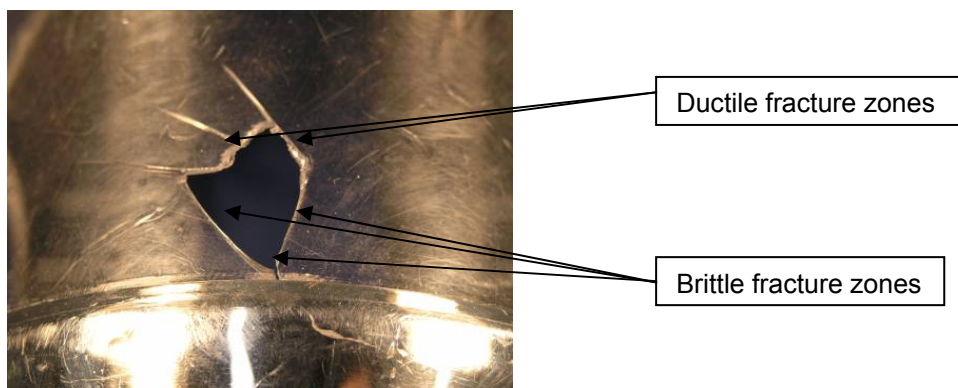

Stamped information in visor surface

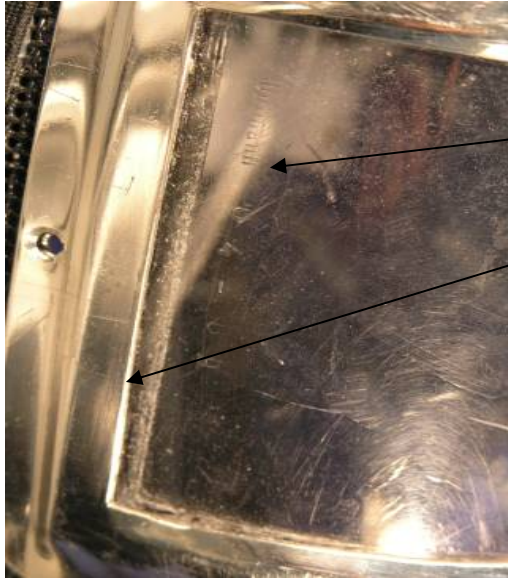

Uhlmann – 04 –09 outside (open surface)

Lexan – inside (border rebate)

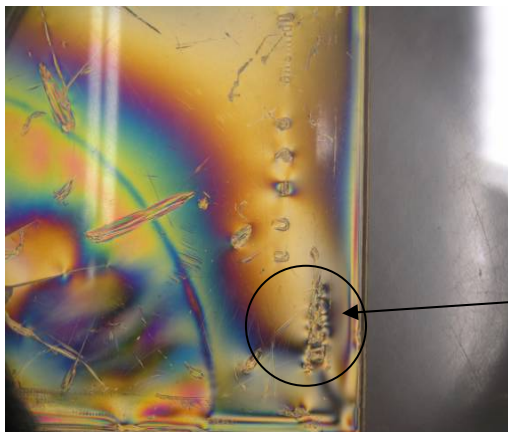

Stress occurrence after stamping

Especially lexan stamp shows a high stress level

Stamped information either hot or cold will cause some stress build up and also can initiate notch effects in the visor. Better to either apply a compatible sticker product and if permanent marking is mandatory a “sand” blasting technique could be considered instead. Best is to put this coding on the exterior face of the visor. This surface normally we be loaded in compression. Which is an more ideal situation when compared to a tensile load.



Fixation nuts

The mounting torque during installation can cause an additional stress in the PC visor. Also if these nuts are tight to heavy the metal outer frame can cut into the visor surface causing a notch effect. In order to prevent overtightening metal infill rings can be used and/or the mounting torque should be defined.

Its' futher advised to put a rubber liner in the rebate circumference of both mask and cover metal. This rubber obviously needs to be compatible with lexan. A Shore A hardness of 65 and sufficient thickness should prevent contact of the lexan with the metal edges upon impact. This should prevent any notch initiation effect from the metal parts and also would allow some deflection of the lexan.

Below is an overview of chemical substances found on this mask

8



As it's known that chemicals may have an adverse effect on the polycarbonate performance there is a need for proper evaluation of the risks involved. It's unknown if such assessments were made.

Especially volatile solvents as used in marker pens and plasticizer used in soft PVC packaging materials are known to give rise to stress corrosion issues with the material. As stresses in these visors cannot be excluded care needs to be exercised to use proper chemical products.

The edge finish of this visor is far from optimal. Edges are sharp and do contain a lot of indentations (notches). These all need to be improved. Tapering of these edges is advised strongly.

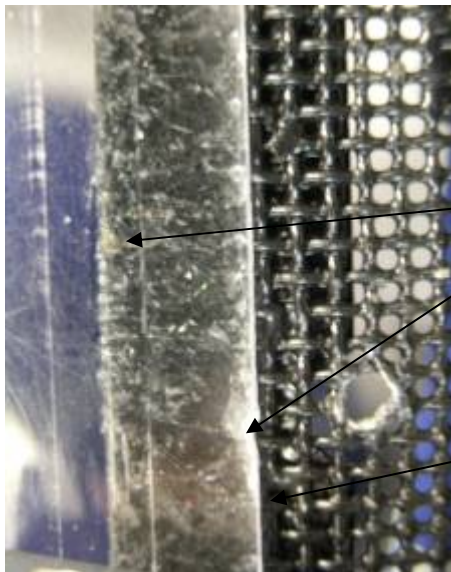

Deep deformations and scratch marks in visor sides.

Sharp and hollow sides !

2.2. Dimensions – Gauge and bending radius

Ulmann Visor - radius evaluation			height 100 mm , length outside 215 mm			
				thickness in mm	3	
			radius in mm		radius in mm	
			outside	average	inside	outer fibre strain if not draped , %
						delta strain %
Lexan visor top	outside	93				
Lexan visor bottom	outside	93	93	90	1.639	
Mask - top	outside	80				
Mask - bottom	outside	77	78.5		1.875	0.236
Metal cover - top	outside	87				
Metal cover - bottom	outside	85	86			
INTRODUCED OUTER FIBRE STRAIN AFTER ASSEMBLY IS +/- 0.24%						

The difference in radius between visor and mask curvature will introduce an outer fibre strain after assembly of the visor of approx. 0.24 %. In principle such a strain can be handled well by lexan. However if incompatible and/or stress corrosive chemicals can come into this area stress corrosion may result from this.

In view of the micro crazes found in this visor it seems very likely that above situation has occurred. Eg. Stress in combination with a critical chemical product(s).

2.3. general

Increase lifetime of the protective visor:

To increase the long-livety of the visor it can be considered to use a sacrificial layer over the real visor. This layer can consist of a thin gauge lexan film which is mounted on the outside over the existing visor. When this film becomes scratched it should be easily replacable.

Such films even don't need drape forming. But can be placed over the visor straight away. A thickness of 500 micron for instance would give an outer fibre strain of 0.3%, which is fully acceptable for lexan.

Visor exchange should be made very simple. This will invite people more to change the visor when deep scratch marks have occurred.

Protective bags:

Its further recommended to transport masks in a suitable bag. Use of soft pvc packaging materials can release plasticizer into the bag and onto the visor causing stress corrosion

Note: pvc plasticizers are stress corrosive products for lexan

Visor exchange:

With this type of visor some advice needs to be given as too installation torque. Too high torque mat create high stress and could also cause a cutting actions of the metal cover

Visor Radius / helmet size:

The visor radius shoud exactly follow the radius of the mask. If more helmet sizes are used this also will mean more visor types need to be available.

Note: One bending radius can never accommodate all sizes.

2.5 Information Uhlmann

Behandlungshinweise – Sicherheitsvorschriften für alle FIE- Fechtmasken mit und ohne Visier

- Bitte prüfen Sie die Maske (Visiermasken und Gittermasken) regelmäßig. Zur Überprüfung des Gitters die Maske gegen das Licht halten. Das Visier auf Kratzstellen überprüfen, den Latz auf Beschädigungen.

- Die Maske immer in der Maskentasche transportieren.

- Für alle Masken gilt: Wenn der Latz feucht geworden ist vom Schweiß, ihn bitte zuerst trocknen lassen bevor die Maske eingepackt wird, um eine Korrosion des Gitters zu vermeiden.

- In der Maske bitte keine Flüssigkeiten oder Klebstoffe transportieren und die Maske nicht zusammen mit schweißnasser Kleidung, Handschuhen oder Schuhen einpacken.

- Jeden Kontakt zwischen Visier und Chemikalien vermeiden, besonders Klebstoffe, Aceton oder andere Flüssigkeiten, die Kunststoffe oder LEXAN angreifen.

- Bitte das Visier sofort austauschen, wenn eine der folgenden vier Situationen eingetreten ist

a) Das auf der Maske eingestempelte Datum liegt mehr als 2 Jahre zurück.

b) Das Visier weist Rillen oder deutliche Kratzspuren auf

c) Das Visier ist nicht mehr transparent (blind).

d) Das Visier ist mit Chemikalien in Kontakt gekommen.

- Bitte sorgen Sie dafür, dass Sie immer ein Ersatzvisier und das Werkzeug zum Wechseln des Visiers mit sich führen. Stellen Sie sicher, dass alle

Schrauben fest sitzen und dass der Rahmen und das Visier korrekt befestigt sind.

- Nur Lexan oder Makrolan-Visiere verwenden, die bei einem Maskenhersteller oder seinem offiziellen Vertreter gekauft wurden.

- Das Visier mit einem weichen Tuch reinigen und nur neutrale Flüssigkeiten wie Wasser zum Reinigen verwenden.

Treatment prescriptions and safety instructions for all FIE-fencing masks with and without visor

- Check that the mesh part of the masks (visor and traditional) is in good condition. This can easily be done by placing the metal wire mesh against

the light. And regularly check that the mask and its bib are in good condition.

- Keep the masks in their bags while transporting them.

- For all types of masks (visor or metal mesh), if the bib of the mask is wet, wait until it dries before putting it away in its bag.

- Do not use the masks to carry containers holding liquids or glues, or to carry clothing, gloves or shoes which are wet or damp from perspiration.

- Avoid all contact between the visor and chemical agents, in particular glues, acetones or other liquids that damage plastics and Lexan.

- In the case of a mask with a transparent visor, change the visor when one of the following four situations occurs first:

a) Within a maximum of 2 years after the date marked on the visor;

b) Appearance of grooves or visible deep marks on the surface;

c) The visor is no longer transparent (opaque);

d) When the visor has been in contact with chemical agents.

- Always be equipped with a spare visor and the tools needed to replace the visor, ensure that all the screws are in place and that the frames and visor are correctly and adequately fitted.

- Only use Lexan or Makrolan visors bought from the mask's manufacturer or its official representative.

- Clean the visor with a soft cloth and only use neutral liquids such as water.

Préscriptions de sécurité et de traitement pour masques FIE sans et avec visière

- Vérifier que la partie du treillis métallique des masques (visière et traditionnel) est en bonne condition. Ceci peut être facilement contrôlé en plaçant

le treillis métallique à contre-jour. Et vérifier régulièrement la bonne condition du masque et de sa bavette.

- Maintenir les masques dans leur sac lors du transport.

- Pour tout type de masque (visière ou treillis), dans le cas où la bavette du masque serait mouillée, attendre qu'elle sèche avant de l'enfermer dans son sac.

- Ne pas utiliser les masques pour transporter des récipients ou souliers mouillés ou humides de transpiration.

- Éviter tout contact de la visière avec des agents chimiques notamment : colles, acétones ou autres liquides agressant les plastiques et le Lexan.

- Dans le cas du masque à visière transparent, changer la visière dès qu'une des quatre situations décrite ci-dessous se produit en premier :

a) Dans la période maximum de 2 années à partir de la date marquée sur la visière ;

b) Apparition de rainurages ou marques profondes visibles sur la surface ;

c) La visière n'est plus transparente (opaque) ;

d) Quand la visière a été contact avec des agents chimiques.

- Etre toujours muni d'une visière de remplacement et des outils pour effectuer le remplacement, s'assurer que toutes les vis sont en place et les

cadres et visière correctement et adéquatement installés.

- N'utiliser que des visières en Lexan ou Makrolan achetées chez le fabricant du masque ou son représentant officiel.

- Nettoyer la visière à l'aide d'un chiffon doux, n'utiliser que des liquides neutres tel que l'eau.